

LASER LINE WIDTH

Ideally, a thin laser line is used in order to maximize the signal intensity at the sensor. Measurement accuracy can be improved by using sub-pixel algorithms with thicker laser lines, assuming any disturbances caused by laser speckle (see below) are small enough.

For both micro and macro line generators, the width of the laser line is proportional to the working distance and the power density decreases for deviations from the specified working distance and line width. The relationship between the square of the line width and depth of focus means that the depth of focus of a laser line required by an application effectively limits the minimum laser line width that can be used and, thereby, the signal intensity at the sensor.

LINE WIDTH DEFINITION

Adjustment of the collimating lens generates a convergent beam. At distance A relative to the fiber collimator, a beam propagation with width B is formed.

$$B = \frac{4 \cdot \lambda \cdot A}{\pi \cdot \varnothing_{\parallel}}$$

B = line width [mm]

A = working distance [mm]

λ = wavelength of laser emission

\varnothing_{\parallel} = cross-section of the collimated laser beam at the $1/e^2$ -level parallel to the active diode strip

LINE WIDTH AND RAYLEIGH RANGE/DEPTH OF FOCUS

The laser lines are focussed at a defined working distance A and attempts at focussing outside of this narrow range produces line broadening and power density reductions.

The range around the nominal working distance, in which the laser line does not increase by more than a factor 1.41, is usually specified as the depth of focus of that laser line and is specified differently for the two types of laser line generator.

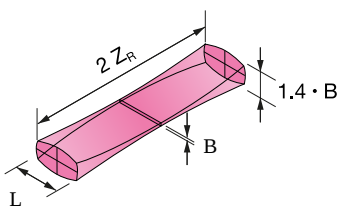

Rayleigh range

LINE WIDTH AND RAYLEIGH RANGE FOR MICRO LINE GENERATORS

For a [Micro Laser Line Generator](#) with line width B (at the 13.5 % level) and wavelength λ , the depth of focus is defined as the Rayleigh range $2z_R$

$$2z_R = (\pi B^2) / 2\lambda$$

For laser spots the line width B is replaced by the spot diameter \varnothing at the 13.5%-level. L is also replaced with the corresponding diameter \varnothing .

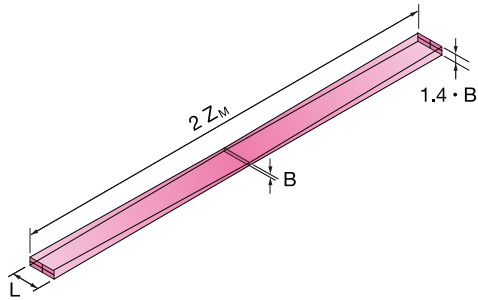

Depth of focus

LINE WIDTH AND DEPTH OF FOCUS FOR MACRO LINE GENERATORS

For a [Macro Laser Line Generator](#) with line width B (at the 13.5 %-level) and wavelength λ , the depth of focus $2z_M$ is defined as:

$$2z_M = 1.75(\pi B^2)/2\lambda$$

For laser spots the line width B is replaced by the spot diameter \varnothing at the 13.5%-level. L is also replaced with the corresponding diameter \varnothing .

This is a printout of the page <https://sukhamburg.com/support/technotes/lasermodules/linebasics/linewidth.html> from 5/6/2026

CONTACT

For more information please contact:

Schäfter + Kirchhoff GmbH
 Kieler Str. 212
 22525 Hamburg
 Germany
 Tel: +49 40 85 39 97-0
 Fax: +49 40 85 39 97-79

info@sukhamburg.com
www.sukhamburg.com

LEGAL NOTICE

Copyright 2020 Schäfter+Kirchhoff GmbH. All rights reserved.

Text, image, graphic, sound, video and animation files and their arrangement on Schäfter+Kirchhoff GmbH webpages are protected by copyright and other protective laws. The content may not be copied for commercial use or reproduced, modified or used on other websites. [\[more\]](#)